



Cone Beam 3D Imaging  
**NewTom**  
what's next

## FIRST IN CONE BEAM, ACCURATE IN RESULTS.

360 degree imaging,  
reduced image scatter  
or artifacts.

Smallest possible focal spot  
and single flat panel create  
the clearest images.

Dedicated digital sensor  
and specific image algorithms  
provide a full range of information.

THE GLOBAL MARKET LEADER.



### First user of Cone Beam in dental field

QR s.r.l. is the name that stands behind NewTom Cone Beam 3D imaging units and we were the creators of Cone Beam technology for the dental field. NewTom 9000 (also known as Maxiscan™) was the very first Cone Beam equipment in the world, which was installed in 1996. It is the forefather of NewTom product line and, in general, of the entire X-Ray units based on Cone Beam technology.

QR's 20 plus years of experience and success in research, development, manufacturing and distribution of NewTom products affirms our commitment to excellence and quality.

QR s.r.l. is based in Italy and all NewTom products are designed and manufactured by our group. Our products represent the Italian tradition of specialized manufacture and NewTom is known all over the world for its reliability, high standards and state-of-the-art technology.

QR s.r.l. is a comprehensive and independently working company consisting of a research and development department (hardware and software), production and technical assembling division, technical support staff, customer service, sales and marketing department and management offices. Our national and international sales network relies on strong and long-term partnerships with all our dealers and representatives spread all over the world.

NewTom's team-oriented staff is committed to provide not only the best product available on the market, but also excellent before and after- sales support, as a happy customer is the best advertisement.

# CONE BEAM TECHNOLOGY

## Cone Beam 3D vs. MSCT

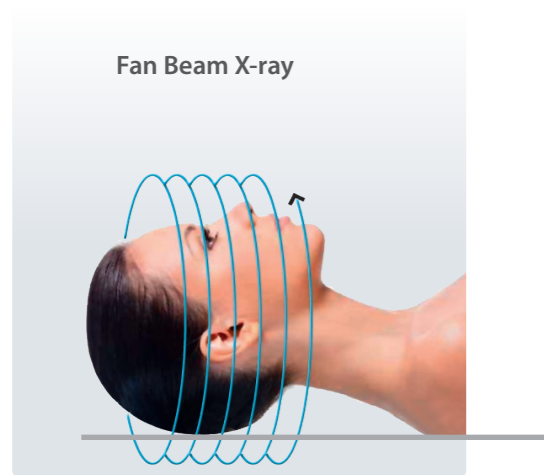

MSCT

MSCT uses a narrow fan beam that rotates around the patient acquiring thin axial slices with each revolution. In order to create a section of anatomy, many rotations must be done. During these repeated rotations, traditional CT emits a high radiation dose, but it leaves a gap of information between each rotation. Therefore software must stitch together the images and calculate what is missing. Cone Beam 3D imaging uses a cone-shaped beam to acquire the entire image in a scan using only one rotation.

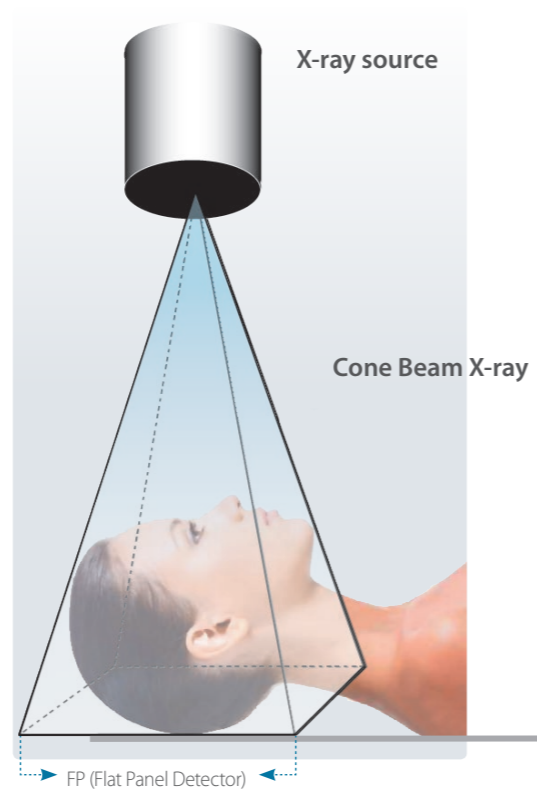

CB3D

The result is a more accurate image without missing information and a considerably lower radiation exposure. The American Academy of Oral and Maxillofacial Radiology (AAOMR) prescribes the use of Cone Beam 3D imaging when evaluating periodontal, implant, and oral/maxillofacial surgery patients. One NewTom scan obtains a complete dentomaxillofacial image in a single database of digital information. Various views of the information in 3D images can be created using NewTom NNT software.

### PRECISE 1:1 SCALE IMAGING

With precise 1:1 scale imaging, NewTom technology eliminates the magnification errors of conventional cephalometric and opg imaging technology. 3D imaging allows the dental professional to identify potentially serious problems, such as airway passage obstructions and soft tissue abnormalities. CB3D imaging technology is the standard of care for implantologists, orthodontists, periodontists and oral/maxillofacial surgeons. Thanks to its design, more similar to a traditional CT, NewTom 5G helps the development of new fields of application.

### HIRES SCAN

NewTom 5G allows to irradiate small portion of body, in order to see small anatomical details. This can be useful for proper implant assessment, because it requires the visualization of all aspects of the mandibular canal and other small parts, such as tooth roots, periodontal ligaments and any present lesions. Only 3D High Resolution imaging produces both the quality and the quantity of details necessary to accurately view those small details.

Accuracy is one of the most important factors, together with dose reduction, also for analyzing middle and inner ear pathologies. NewTom has been recognized as an important diagnostic tool for most of ear pathologies.

### Multiple Fields of View

The scanner's FOV determines how much of the patient's anatomy will be visualized. If using a flat panel detector (FP), the dimensions of their cylindrical FOV can be described as Diameter by Height (DxH).

Nowadays, the need to scan different R.O.I. (Region Of Interest) with different dimensions is regulated by international standards in order to reduce the effective dose for the patient following the "As Low As Reasonably Achievable" (ALARA) dose principles. In particular, the use of a small FOV, in addition to reducing the dimension of the irradiated region, allows for a dramatic increase in the accuracy and resolution of images for all the pathologies and diagnosis where it is necessary to identify very small details at high definition.

Small FOV are mostly used in dental field for endo, perio, implant surveys and for the localization of impacted teeth and in the medical field for finger fractures, ENT diagnoses and all the medical cases needed a very high definition. One single rotation of the biggest FOV permits to scan patients where the referring doctors need to see the major part of the anatomical part interested. In dental field, these FOV can irradiate big regions of the head, which includes the roof of the orbits and the Nasion down to the hyoid bone, and it is used in orthodontics, orthognatics and maxillofacial surgery. In medical field, big FOV permits to irradiate a big part of the body, allowing to visualize all the extremities (e.g. feet, ankles, wrists, hands and in some cases even hips prosthesis), airways for sleep apnea obstruction and cervical region.

In all the cases NewTom has different dose protocols in order to further reduce the dose. Finally, NewTom Team has found the proper balance between FOV, dose and accuracy, using different dose protocols for each single FOV and diagnosis. Between these, medium FOV are also selectable. They are used in the dental field for TMJ, pano's and implant surveys, because they irradiate from the middle of the orbits down to the Menton (vertically) and condyle-to-condyle (horizontally). In the medical field they can be used for scanning in one acquisition both the TMJ and ear regions without useless and dangerous double exposures for most of the patients.

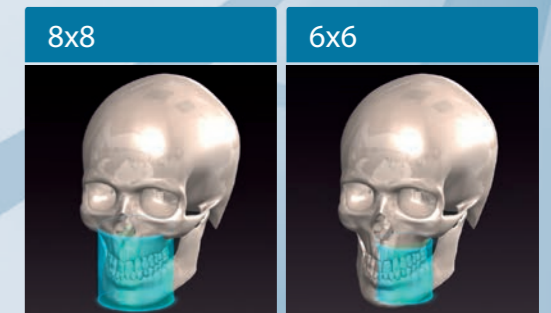
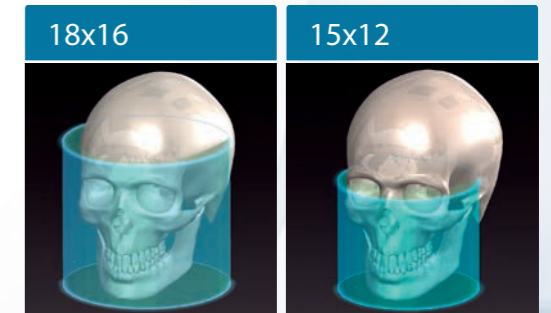





## ECOSCAN

The EcoScan is the novelty among the various scan protocols available on NewTom devices.

This protocol reduces scan time and X-ray emission time as well as dosage, without affecting the high quality of the images.

## SafeBeam™ Technology for automatic dose exposure

Only NewTom systems employ SafeBeam™ technology, the safest technology available for patient and staff. Featured in all NewTom units, SafeBeam™ automatically adjusts the radiation dosage according to the patient's age and size.

This technology uses intermittent bursts of radiation, which last only milliseconds, during image acquisition. Other systems deliver a constant stream of radiation and the same amount of radiation, whether scanning a adult or a small child. SafeBeam™ technology automatically and continuously monitors system operations, thus eliminating the possibility of unnecessary exposures. In conjunction with our patented SafeBeam™ technology, when compared to other CB3D systems, NewTom 5G has a wider range of adjustments for the X-ray power and quantity (kV=110 and mA=1-20). As a result, patient exposure is tailored and image contrast remains consistent regardless of patient size or bone density.

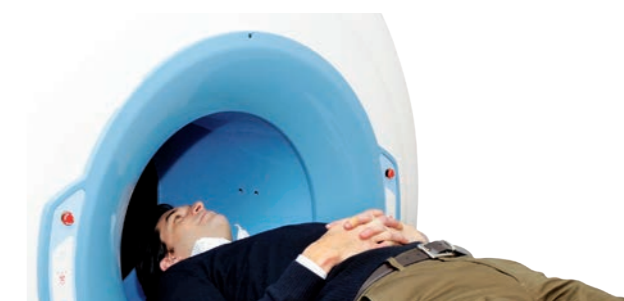

## Greater patient comfort and treatment acceptance

All NewTom units add a sense of comfort for the patients, allowing them to relax during the scan and limiting the patient movements, in order to improve the image quality. NewTom scans provide the practitioner and the patient with unprecedented visualization of anatomic information. This leads to a better diagnosis and better treatment planning, increasing the patient treatment knowledge. The result is a more cooperative and informed consent process along with understanding the need for treatment and improving the doctor-patient relationship.



# NewTom NNT analysis software

NewTom NNT analysis software is the perfect solution for 2D and 3D imaging. NNT allows the creation of different kinds of 2D and 3D images in a 16 bit grey-scale and it takes only few seconds to evaluate the data taken during the scan. The software is totally designed by NewTom engineers and, thanks to the various application modes specifically design for different fields of use, it fulfills all the requirements and needs of our clients. NNT, with a new integrated implant planning application, can easily identify and mark root inclination, position of impacted and supernumerary teeth, absorption, hyperplastic growth, tooth structure anomalies and the mandibular canal. The software delivers extremely high quality images which facilitate safer surgical planning. The images can be gathered and used in report templates which are defined by users and can be delivered digitally (burnt to a CD or DVD), on paper, film or pdf. The software is available in different versions: the Expert version is used for taking scans, the Professional version permits data processing and the NNT Viewer gives other professionals the ability to view the images processed by NNT. The images can be exported in DICOM 3.0 format at any time, in order to allow easy sharing between imaging centers and referring doctors. The NNT DICOM Datasets are fully compatible with most third party software programs.

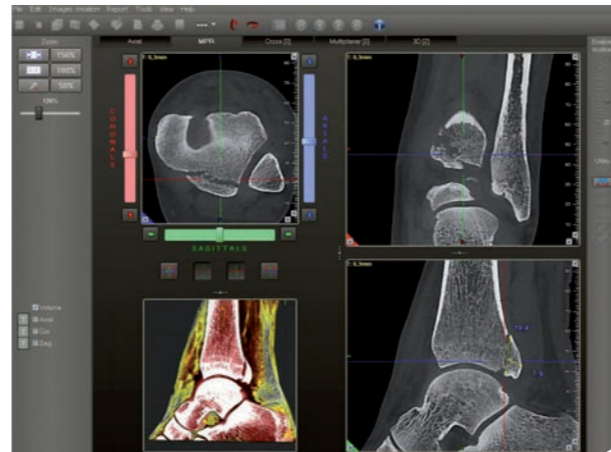
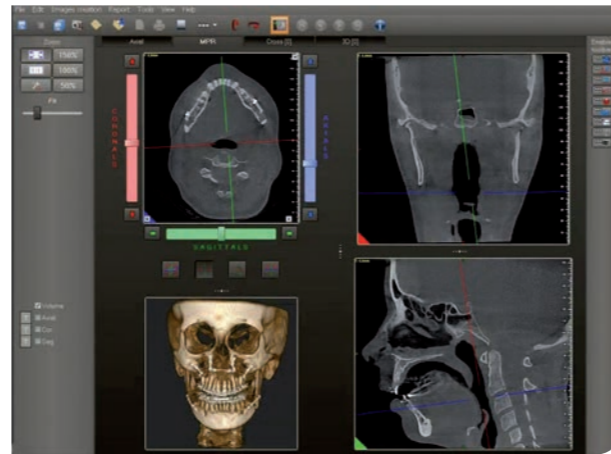

## ➤ SUPERIOR THIRD-PARTY COMPATIBILITY

NewTom images are compatible with most major third-party software programs on the market as well as guided implant and maxillofacial surgery software. 3D imaging data is highly adaptable and can be imported and used in countless diagnostic and educational modes. Software segmentation adjusts the amount of soft tissue, underlines the hard tissue and accentuates the structure of the skull. Different intuitive software applications allow the creation of realistic models that can be positioned on images obtained from the scan. This creates infinite options that help in diagnosis, treatment planning, pre-surgical analysis, and patient education.



## Newtork set-up

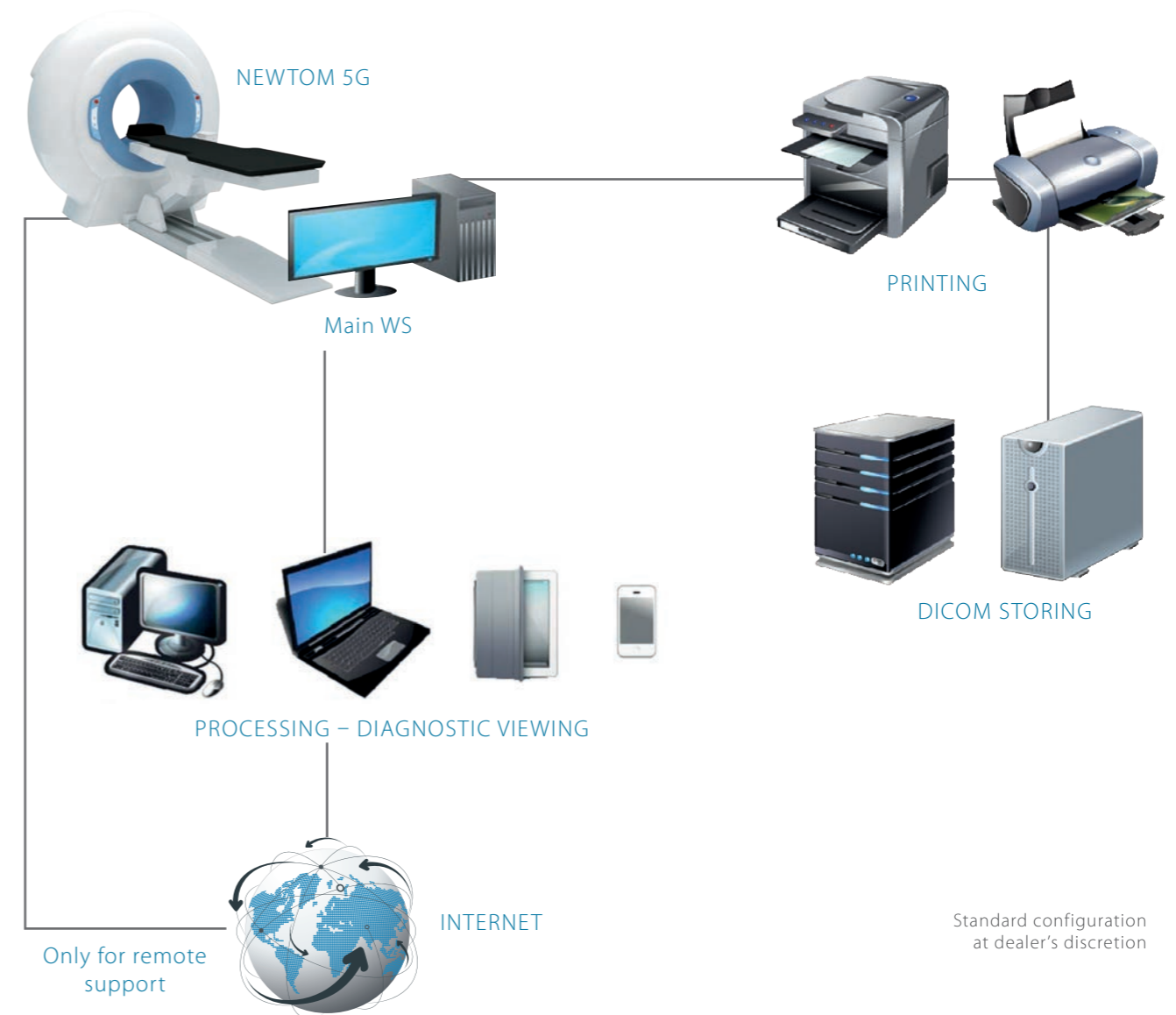

Standard configuration at dealer's discretion



## NewTom Implant Planning

NewTom Implant Planning is a software package that allows the creation of 3D implant simulation on any PC. It can simulate the implant placement on 2D and 3D models, identify the mandibular canal, draw panoramics and cross sections of the bone model.

It also shows the 3D bone model and calculates the bone density.

NewTom Implant Planning is used to plan prosthesis implant surgery in a faster, safer and more efficient way. It also allows the ability to export in .stl format.

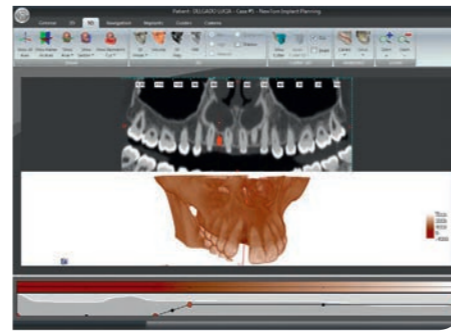
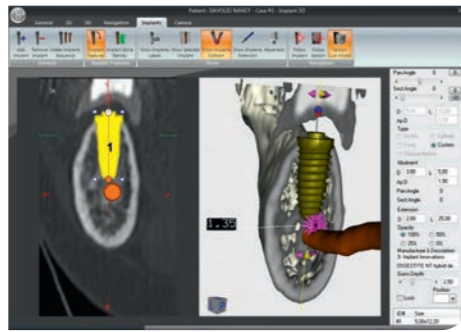

### A useful communication & motivation tool

All the images generated by NewTom Implant Planning can be used to communicate with the patient, in compliance with the compulsory rules about the informed consent. The most interesting cases can be saved on a CD-ROM through the image exporting functions. Thanks to the user-friendly interface, learning is a quick matter.

### Measures and information

NewTom Implant Planning can plan the prosthesis implant surgery by identifying both the implant and the mandibular canal position. It measures accurately the proportion and density of the bone and makes the surgery more effective and faster.

#### 2D & 3D

It generates panoramics, cross sections and 3D bone models reading axial slices.

This helps identifying all the anatomic aspects of the patient, the mandibular canal, the bone structure and the exact implant positions, in order to facilitate the surgery.

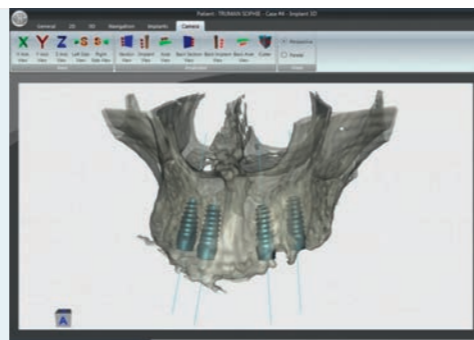

#### SUPPORTED FORMATS

NewTom Implant Planning reads axial slices saved in DICOM 3.0 or in NNT format, which is the same format used by NewTom 5G, NewTom VGi, NewTom GiANO and previously released systems (NewTom VG, NewTom 3G and NewTom 9000).

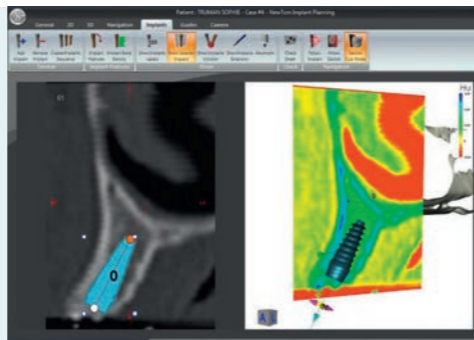

## CLINICAL CASES

### Implants

CB3D is one of the most effective tools available for analyzing implant sites. 3D images can accurately identify possible pathologies and structural abnormalities. Cross sectional and panoramic views facilitate various measurements such as: height and width of the implant sites, mandibular edentulous site, a potential implant site near the mental foramen, width of the buccal/lingual ridge and cortical bone density. 3D images highlight the cortical bone thickness, the cancellous bone density, the inferior alveolar nerve and mental foramen location. They also influence the choice of the appropriate implant to be used, its placement, its width and consideration of "die back" from dense cortical bone.

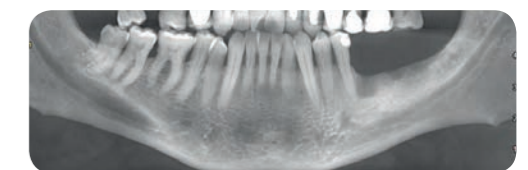
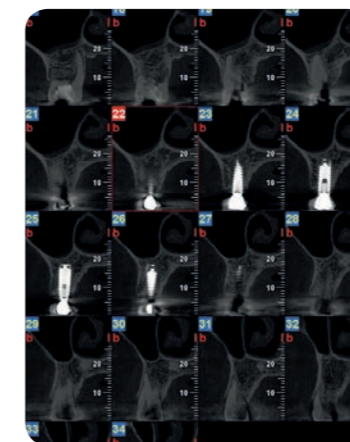
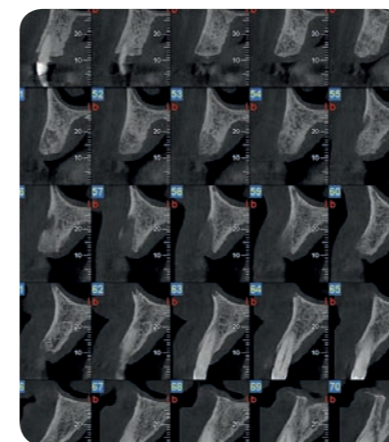
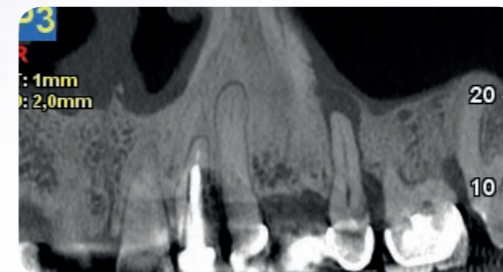



## Endo-Perio

In order to perform certain procedures, like treating a fractured tooth, mandibular canal therapy and caring for the surrounding tissue, endodontic and periodontic specialists require extremely high quality images that will allow them to identify every detail of the treatment area, make an accurate diagnosis, and establish an effective treatment plan. Upon carrying out a thorough examination of the area in question, the user will gain a full appreciation for the device's less invasive nature and greater suitability.

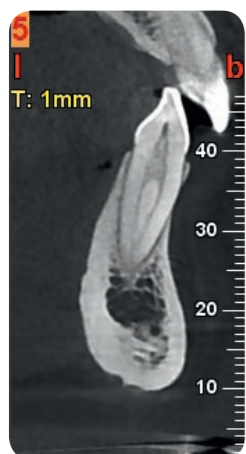
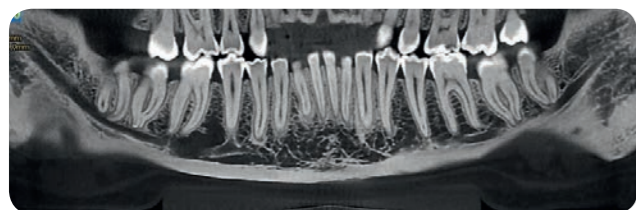

## TMJ

CB3D takes the examination of the Temporomandibular Joint to a new level. After a single scan, Sagittal and Coronal views can be sectioned to show joint space and pathologies. 3D image reconstruction can clearly provide detailed information of the TMJ and Cervical Spine anatomy. A wide panoramic view provides a quick screening tool, where differences in condylar and ramus height as well as other dental pathologies can be checked.

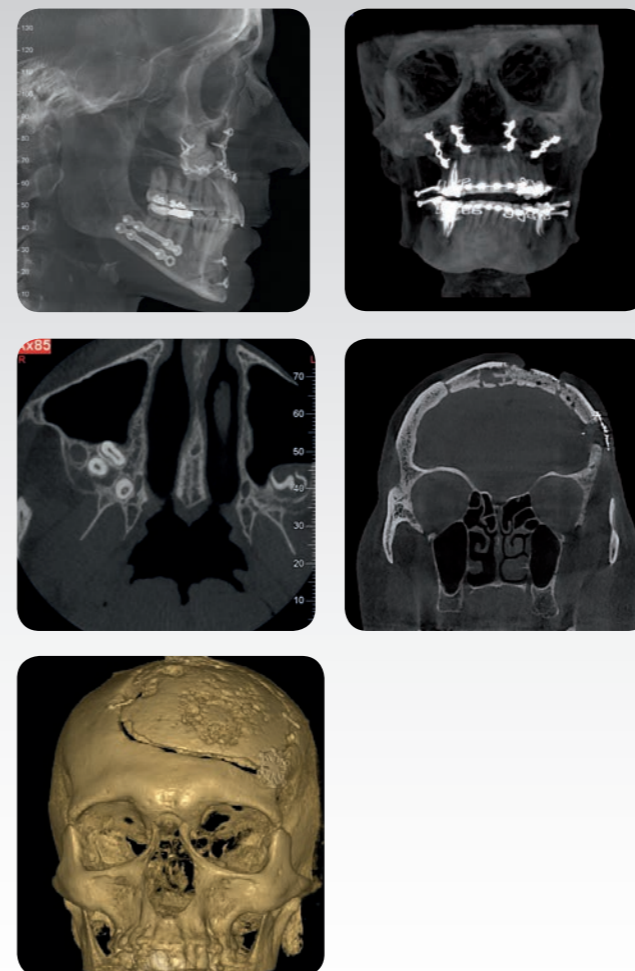
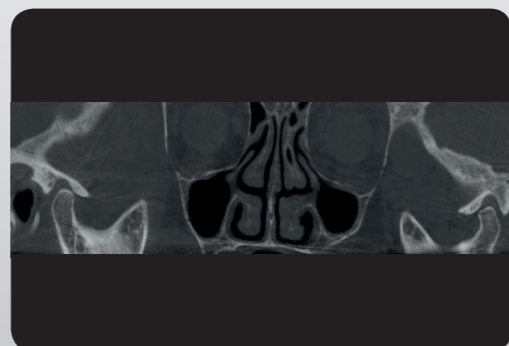
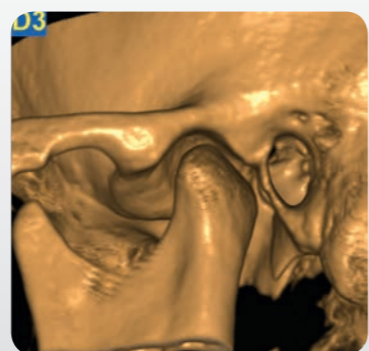
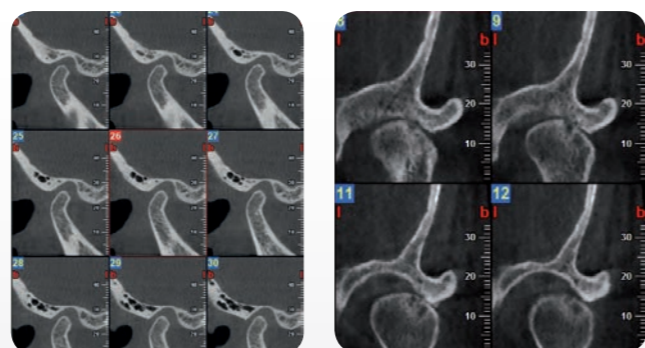

## Oral and Maxillofacial Surgery

This discipline deals with the correction of various soft and hard tissue diseases afflicting the maxillofacial area. Scans performed using NewTom devices precisely illustrate specific characteristics, such as the presence of teeth or fractures, bone density and depth, and the shape and the inclination of the root. Furthermore, in the case of post-operative scans, the presence of any metallic elements will not affect image quality. On the contrary, thanks to the low number of rays necessary, the scattering effect is almost non-existent, thus allowing the anatomical structures scanned to be clearly displayed. The detailed images obtained using the MIP and Volume options generate cooperative relationships between doctors and their patients.

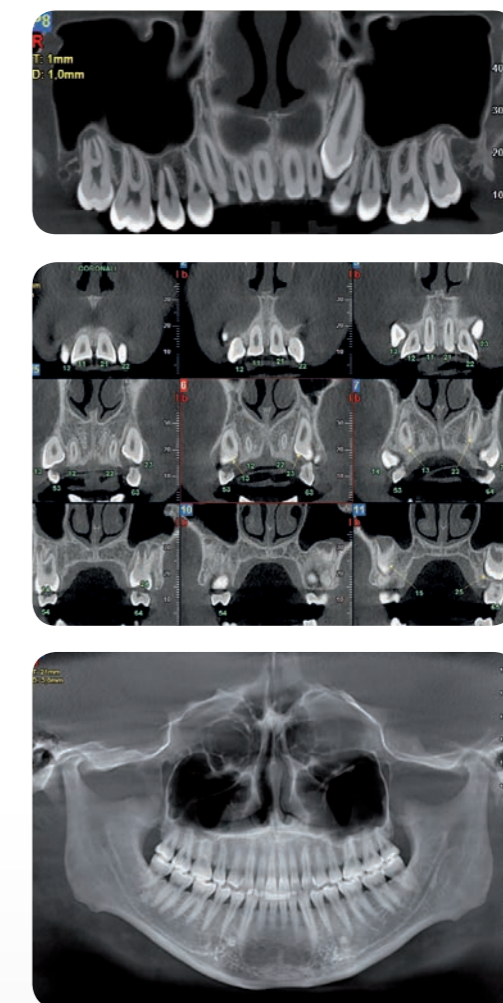

## Orthodontics

Thanks to its three-dimensional image acquisition capability, Cone Beam (CBCT) radiology generates various image types including panoramic, cephalometric and 3D images, all of which are ideal for orthodontic and aesthetic procedures, as well as for the treatment of more serious diseases. 3D images are capable of clearly illustrating specific details, such as the buccal bone and the roots of the teeth. For the purpose of determining the existence and the form of an impacted tooth (and its roots), above all in the maxilla, there is a significant difference between the descriptive capacity of a two-dimensional radiographic plane and that which is offered by three-dimensional imagery. 3D images provide a comprehensive representation of the scanned area, even allowing for the angle of view and the depth of the reconstructed images to be modified.



## ENT Protocols

The unit's exceptional precision and various FOV possibilities provide for a clear view of the airways, sinuses and ear structures. The scans are carried out using the most suitable radiological parameters in order to avoid any unnecessary ray emissions. During the pre-examination phase, the operator selects the most suitable protocol for the anatomical area to be analyzed. Most examinations carried out using conventional CAT/CT scans can also be performed with the scan devices, which, in contrast, provide for more detailed images while simultaneously decreasing patient exposure.

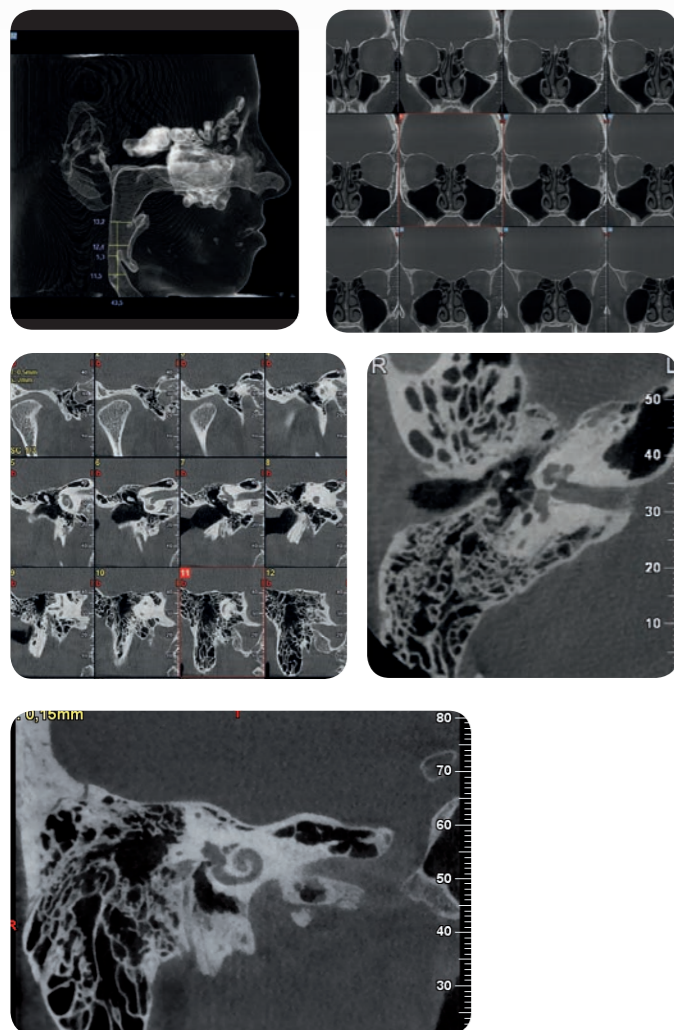

## Cervicals

A cervical spine X-ray can help find the cause of symptoms such as neck, shoulder, upper back, or arm pain, as well as tingling, numbness, or weakness in the arm or hand. It can detect fractures in the cervical vertebrae, dislocation of the joints between the vertebrae, subluxations of the vertebral bodies and cervical abnormalities. CB3D is excellent for characterizing fractures and identifying osseous compromise of the vertebral canal because of the absence of superimposition from the transverse view. The higher contrast resolution of CB3D also provides improved visualization of subtle fractures. The scan can provide patient comfort by being able to reconstruct images in the axial, sagittal, coronal, and oblique planes from one patient positioning.

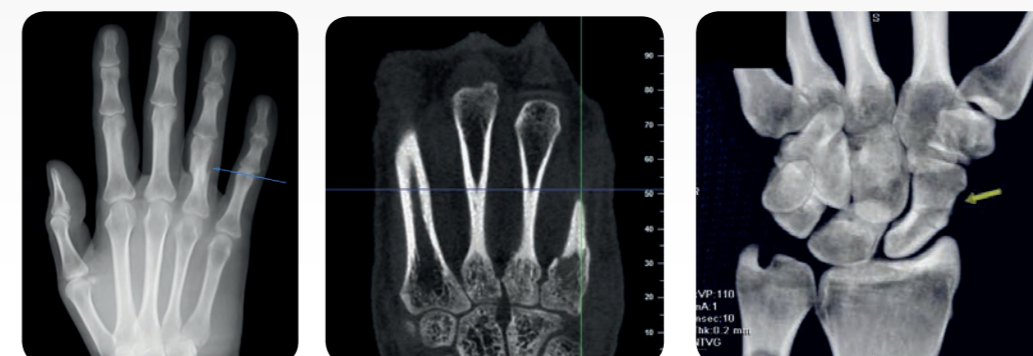
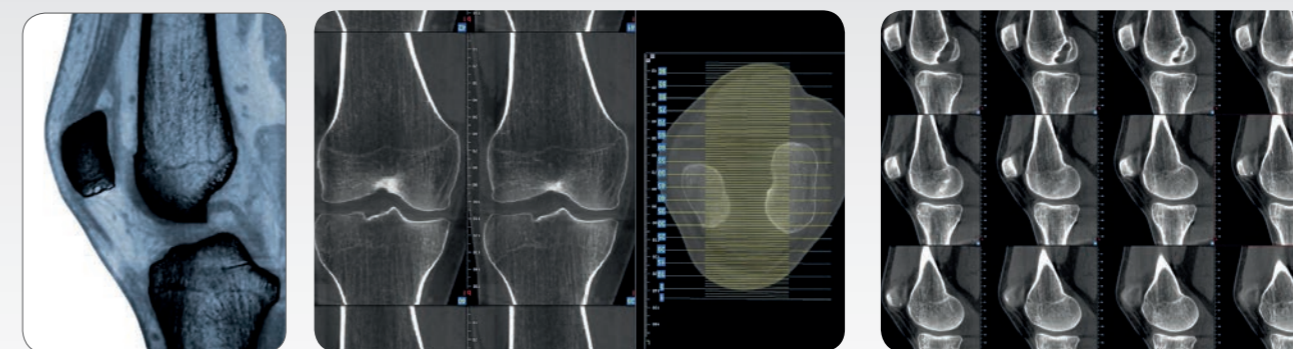
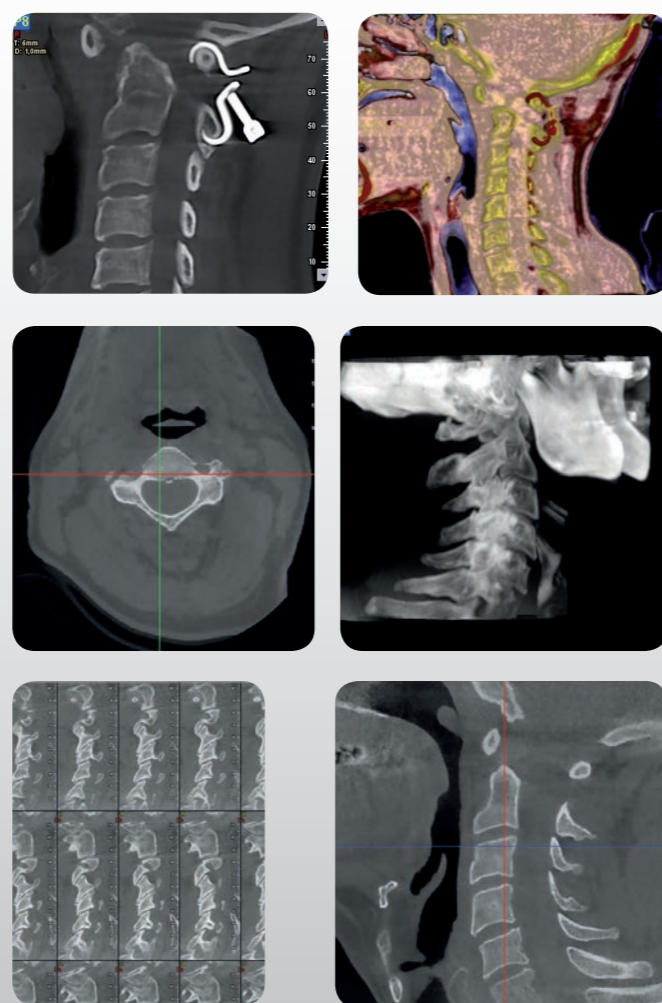

## Orthopedics

Bone X-ray is used to detect fractures or dislocated joints, ensure that a fracture has been properly aligned, evaluate injury or damage from conditions such as infections, arthritis, abnormal bone growths, locate foreign objects, evaluate changes in bones and detect degenerative conditions of the bone. For all these pathologies, the multiple views due to the 3D dataset allow specialists to assess the degree of pathological displacement of any fractures or dislocations.

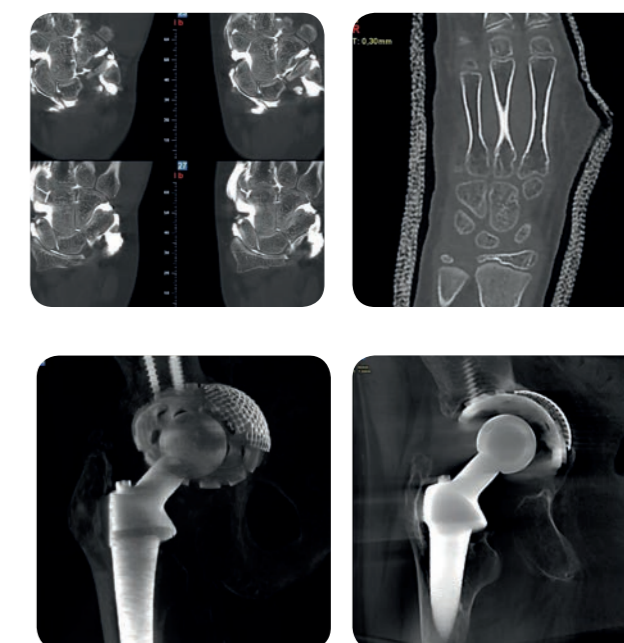



## Veterinary

NewTom 5G provides veterinary practices with an essential, non-invasive diagnostic tool. The research in this field is an important part for deepen our knowledge of what we know about diagnostic imaging and treatment in every medical fields. The value of 3D, however, is directly related to the quality of the images obtained. Poor images can result in missing a foreign body, bone cancer or a fracture. Besides, the risk of missing or misinterpreting a problem, due to poor radiographs, can cost the practice money. An exam performed with NewTom 5G can be useful for: nasal/sinus disease, middle ear/chronic external ear disease, thoracic imaging, pre-surgical planning, skull, spinal, pelvic evaluation, fracture evaluation, etc.

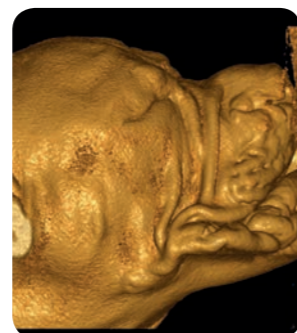
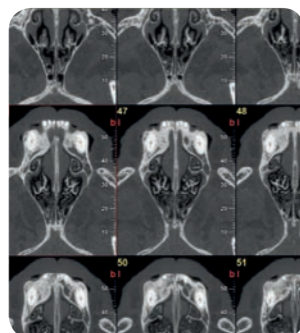
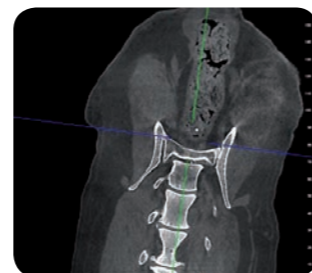
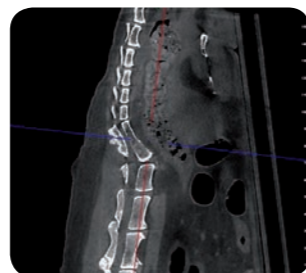
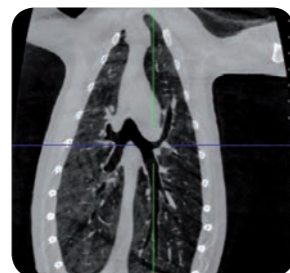
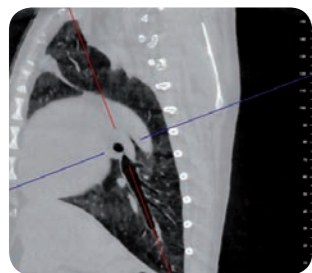
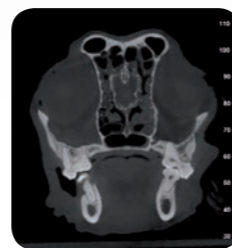
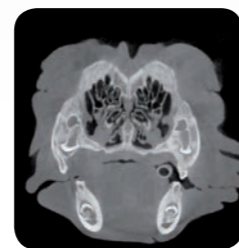
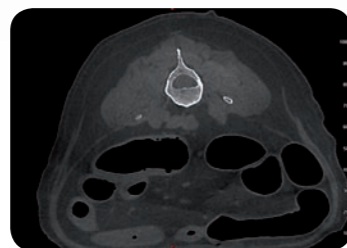

# 5G

## NEWTOM BENEFITS

**NewTom 5G**, from the company that was the first to use the Cone Beam technology in dental field, represents the newest in CB3D technology. NewTom 5G takes an image at every degree of rotation, 360° rotation = 360 images, increasing the range of possibilities for image manipulation. It couples a revolutionary flat panel X-ray detector technology with a very small focal spot (0.3mm), to produce the clearest, sharpest images possible. NewTom 5G features an **adjustable field of view**, which allows doctors to irradiate just the right volume, depending on the different clinical applications. The size of FOV can vary from the smallest 6x6 cm to the biggest 18x16 cm and they can be selected directly from the software, before the scan. NewTom 5G emits a lower radiation in comparison with conventional CT, by using a "pulsed" emission, that unlike other systems, activates the X-ray source only when required and, for a full scan, it takes no more than 5 seconds of total exposure. With a fascinating design, users can explore **new clinical applications**, thanks to the open, pass-through style gantry and a motorized patient table. The supine position of the patient during the scan and the reduced scan time add comfort and stability for an **excellent result in terms of image quality and patient satisfaction**. The small footprint and the variable positioning make NewTom 5G the best choice for locations, where space is at a premium. NewTom 5G does not need air-conditioned rooms, its weight does not require reinforced floor and it can function in rooms without complicated and expensive radiation protection structures. All the operations executed by NewTom, the patient's examination and the following calculations, are **computer guided**. The user, when performing the scan, is supported by user-friendly menus. Each step is associated to a mouse-activated icon. Following the same process, one can enter the integrated file of image-data.

A greater comfort for patients leads to a better acceptance of the treatment.

**SafeBeam™ Technology** adjusts the radiation dosage for patient safety.

**Multiple FOV** and different scan modes are selectable from the software and adaptable to various fields of application.

The margin of error is reduced thanks to the precise 1:1 scale and a 16-bit grey scale.

**NNT software** makes the image sharing process easier.





# SPECIFICATIONS

## 3D

X-ray source	High frequency, rotating anode: 110 kV; 1-20 mA (pulsed mode)					
Focal spot	0.3mm					
Acquisition technique	Single scan and Cone Beam acquisition SafeBeam™ control reduces radiation based on patient size					
Scan time	18s to 36s					
X-ray emission time	2,4s to 7,3s					
Image acquisition	240/360/480 images – 360 degree rotation					
Image detector	Amorphous silicon flat panel, 20 cm x 25 cm Field of View (7.87 in x 9.84 in)					
Signal grey scale	14-bit scanning, 16-bit reconstruction					
Multiples scan modes	FOV sizes D x H		Voxel size options (µm)			
	Centimeters	Inches				
Standard Scan	<b>18 x 16</b>	<b>7.09x6.30</b>	<b>300</b>	<b>250</b>	<b>200</b>	<b>150</b>
–	15 x 12	5.90 x 4.72	300	250	200	150
Boosted Scan	12 x 8	4.72 x 3.14	300	250	200	150
	8 x 8	3.14 x 3.14	300	250	200	150
HiRes Scan	<b>15 x 5</b>	<b>5.90 x 1.97</b>	<b>150</b>	<b>125</b>	<b>100</b>	<b>75</b>
	12 x 8	4.72 x 3.14	150	125	100	75
	8 x 8	3.14 x 3.14	150	125	100	75
	6 x 6	2.36 x 2.36	150	125	100	75
Patient positioning	Supine		Motorized patient table + laser			
Reconstruction time	Less than 1 minute					
Weights and dimensions	Scan unit	Width	175 cm - 68.9 in			
		Depth (max)	360 cm - 141.8 in (with patient table w. stretcher)			
		Height	178 cm - 70.0 in			
		Gantry	58 cm - 22.8 in			
		Total weight	650 kg - 1433 lb (with patient table w. stretcher)			
Software	NNT™ with free viewer and sharing application					
Power Required	10A @100/115V~, 6,3A @200V~, 5A @ 220/230/240V~, 50/60 Hz					

Specifications subject to change without prior notice.

## NewTom Today's standard of care

- > Free Viewer and Sharing Application
- > Full DICOM 3.0 Compliant
- > Improved Software Integration
- > Small Footprint



Dimensions in centimeters [dimensions in inches]

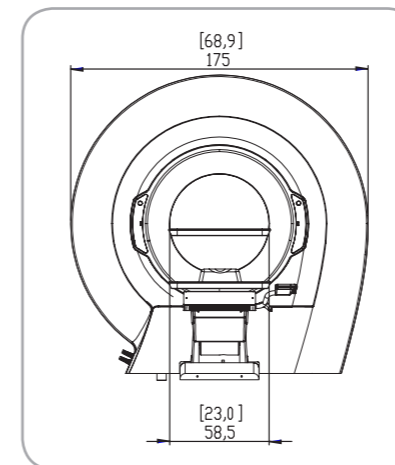

NewTom 5G with patient table

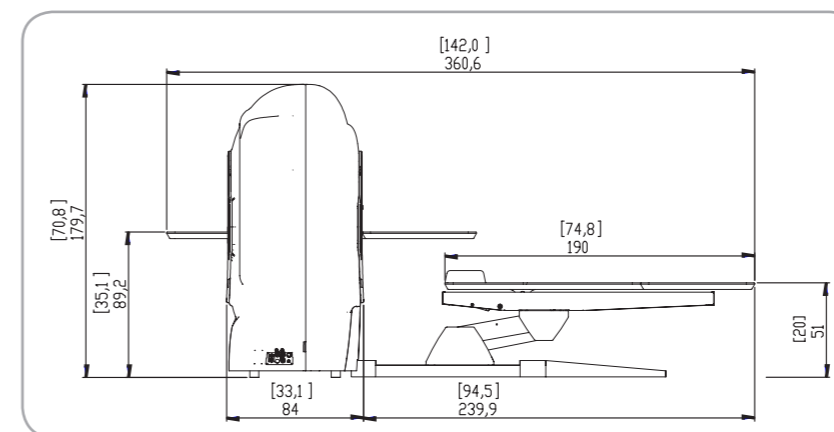
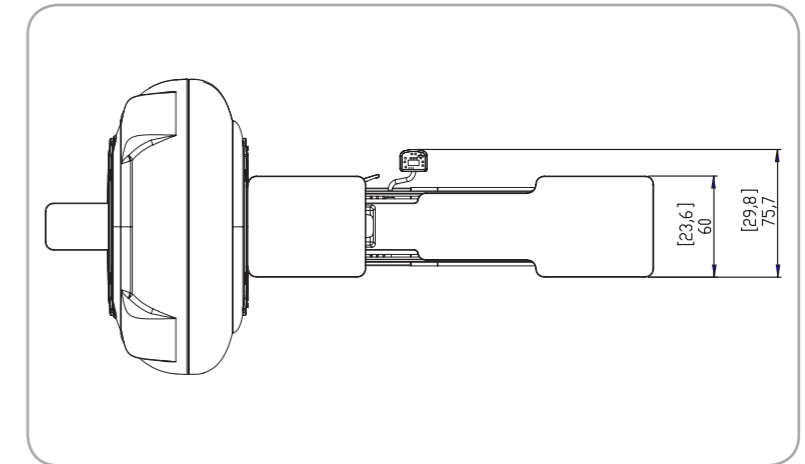

NewTom 5G with patient table w. stretcher

